

Wireless Digital Video Doorbell

User's Manual

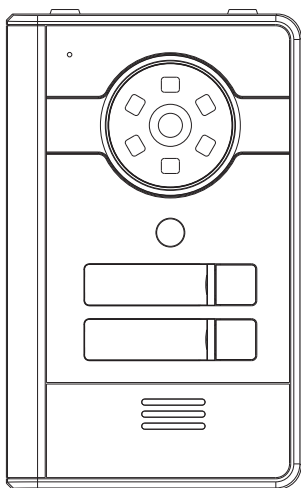

Door Camera

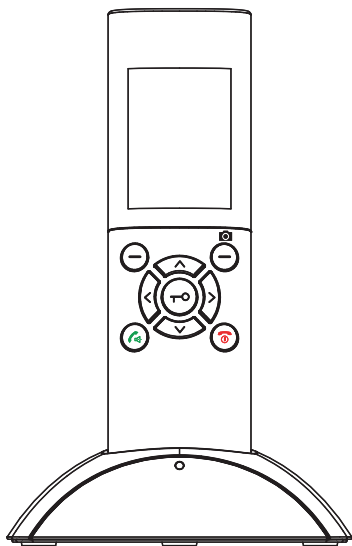

Indoor Handset

■ Remark

Please follow the user manual for correct installation and testing. If there is any doubt, please call our tech-supporting and customer center.

Our company applies ourselves to reformation and innovation of our products. No extra notice for any change. The illustration shown here is only for reference. If there is any difference, please take the actual product as the standard.

CATALOG

Product Features	1
Package Contents	2
Product Pictures	3
Installing Batteries	4
Installation Instruction	5
Diagram	6
Settings	8
Engineering Mode	17
Operations	19
Technical Parameters	23
Notes on Installation & Usage	25
Safety Instructions	27

Product Features

- 2.4" TFT LCD display
- Video resolution: 320x240, with 15 frames per second
- Wide angle lens and LED for night vision
- Long standby door camera (battery or DC 12V)
- Waterproof door camera Ip55
- Microphone, speakerphone
- Basic video intercom, monitoring, remote unlocking and anti-dismantle alarm feature
- Brightness and talk volume are adjustable
- 1 door camera supports up to 4 indoor handsets
- Transmitting distance: up to 500m range in open area
- DIY installation to save labor cost
- PIR function(Optional, DC12V power supply only)

Package Contents

Once you have unpacked your product, make sure that all the parts shown below are available. If any piece is missing or broken, please promptly call your dealer.

Parts of door camera

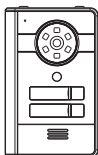

Door Camera



Cable Cover



User's Manual



Power Adapter

(Optional, for PIR function, 12V, 500mA)



Screws

Parts of indoor handset

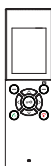

Indoor Handset



Lithium Battery



Charger Base

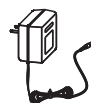

Power Adapter
(12V, 500mA)

Product Pictures

Door Camera

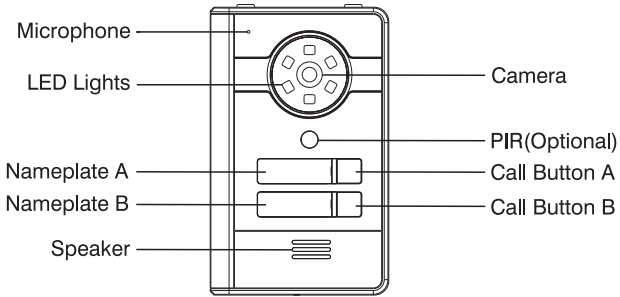

Indoor Handset

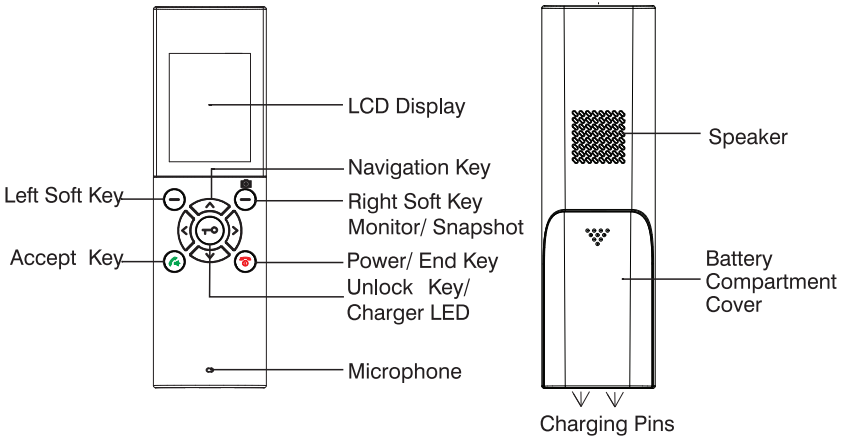

Charger

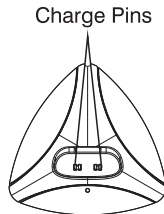

Installing Batteries

Indoor Handset

The rechargeable lithium battery (3.7V, 1100mAh) comes with your indoor handset. Install the battery before use.

1.

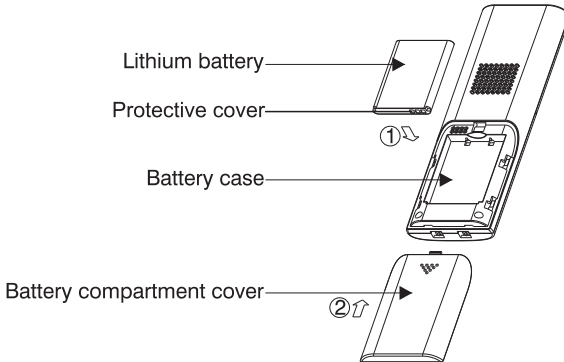

2. Insert new battery as indicated, matching correct polarity(+,-).

3. To replace the battery cover, slide the cover up until it snaps in place.

Notes:

1. To activate battery please remove protective cover from the battery prior to use.

2. The battery needs to be replaced if it doesn't recover full storage capacities after recharging.

3. When replacing the battery, make sure using good quality re-chargeable lithium battery. Never use other battery or conventional alkaline battery.

Door Camera

1. Install two C size 1.5V batteries (not supplied) into the battery compartment or connect with DC 12V power adapter to turn on the door camera(PIR for the DC12V independent power supply).

2. Drill one screw to fix the battery cover up.

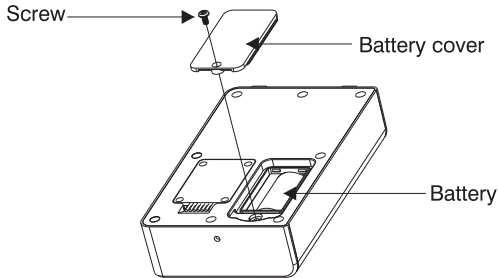

Installation Instruction

Indoor Handset

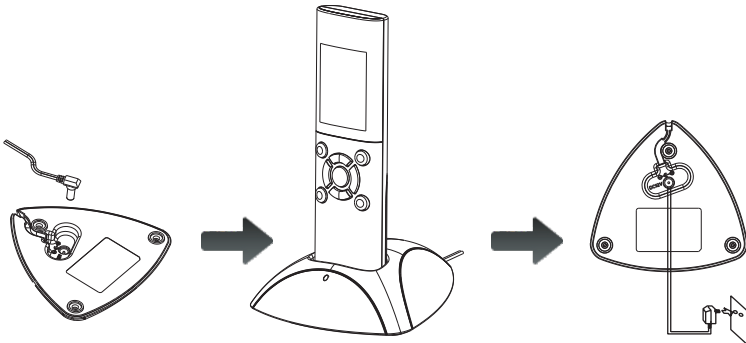

Connect the modular end of the DC power adapter to the power jack of the charger, then plug the DC adapter into a standard AC wall outlet.

Charging Indoor Handset

! Important Note: Before initial operation, **YOU SHOULD FULLY CHARGE THE INDOOR HANDSET** for about 5 hours.

To charge the indoor handset, you should place it on the charger base.

Diagram

Connection Mode 1

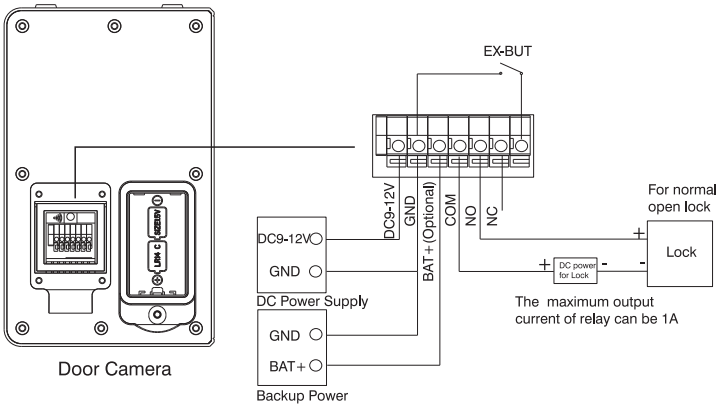

Connection Mode 2

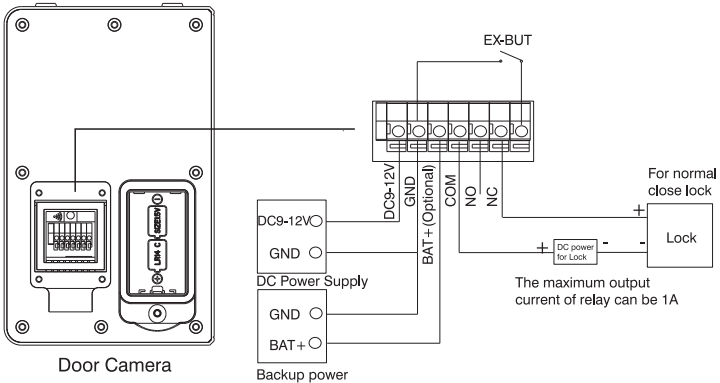

Note: The door camera may be powered by the batteries or the power supply (not included). Do not use batteries and power supply together at the same time. If the door camera is powered by power supply, the monitor feature is available. If the door camera is powered by batteries, the monitor feature is not available until the power mode is changed to power consumption mode (see page 18).

Door Camera

1. After wiring from the connection terminal, tense the cable. Drill the screws on the cable cover of the connection terminal.

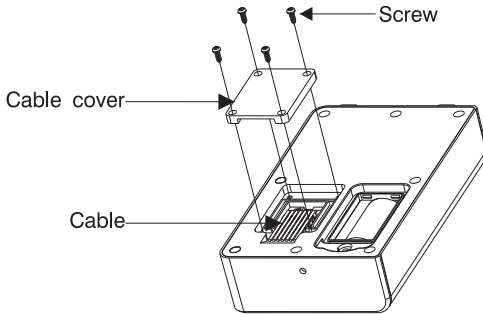

2. Choose a proper location for the door camera. Be sure to consider the average height of visitors. Drill screws to fix bracket in the wall. Hang the door camera on the bracket. Drill screws to fix door camera and finish the installation.

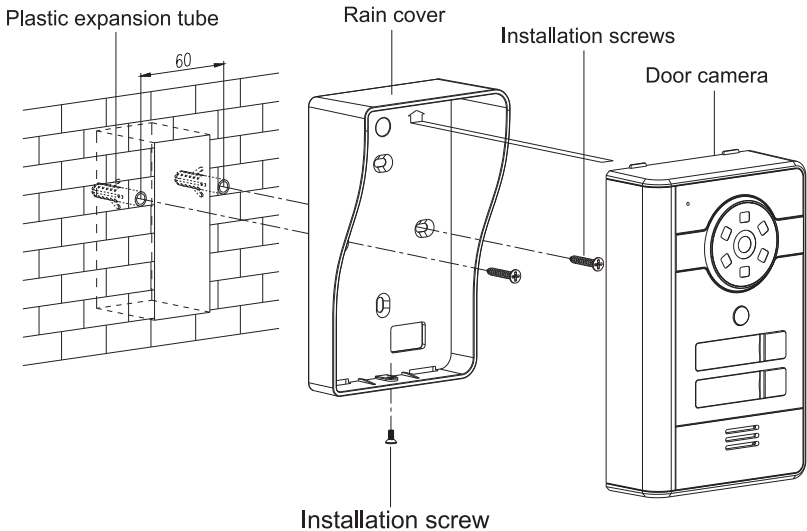

Settings

Turning On/ Off

To turn on or off indoor handset, press and hold .

Power on the indoor handset, the system will enter into the following interface:



Note: When the battery power of indoor handset is insufficient, it will display an indication icon  and warning tone. The indoor handset will automatically turn off. You need to charge it.

Press  to select the **Menu**, then the system will enter into the following interface:

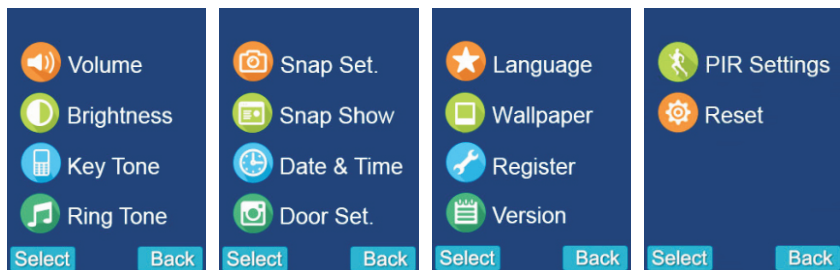

Chapter 1: Volume



This function allows you to adjust the volume (9 levels are adjustable) during a call.

1. Press **Up** (▲) or **Down** (▼) to choose "Volume" menu, then press (⊖) beneath **Select**.
2. Press **Up** (▲) or **Down** (▼) to choose talking volume(9 levels are adjustable), and press **Left** (◀) or **Right** (▶) to adjust.
3. Press **Up** (▲) or **Down** (▼) to choose ringtone volume(9 levels are adjustable), and press **Left** (◀) or **Right** (▶) to adjust.
4. If you want to set the ring time, you can press **Up** (▲) or **Down** (▼) to choose Ring Time(1-30 seconds are selectable), and press **Left** (◀) or **Right** (▶) to adjust.
5. When setting Ringing Time at 0s, indoor handset is on mute mode.
6. Press (⊖) beneath **Select** to save the settings and return to the previous menu.

*Note: Also, you can use **Left** (◀) or **Right** (▶) key to adjust the ringtone volume in the standby mode.*

Chapter 2: Brightness

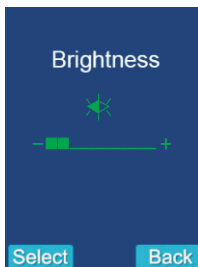

This function allows you to adjust the brightness (9 levels are adjustable).

1. Press **Up** (▲) or **Down** (▼) to choose "Brightness" menu, then press (⊖) beneath **Select** .

2. Press **Left** (←) or **Right** (→) to select the light level that you like. Each time you press **Left** (←) or **Right** (→), the indoor handset displays with the selected light level .
3. Press (⊖) beneath **Select** to save the settings and return to the previous menu.

Note: Also, you can use Up (↑) or Down (↓) key to adjust the brightness in the standby mode.

Chapter 3: Key Tone

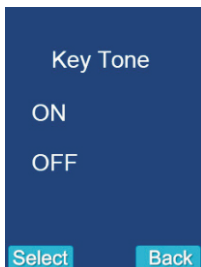

Every time you press a key, your indoor handset acknowledges it with a key tone. You can disable the key tones. In certain error conditions, there will be a warning tone when an incorrect key is pressed.

1. Press **Up** (↑) or **Down** (↓) to choose "Key Tone" menu, then press (⊖) beneath **Select** .
2. Press **Up** (↑) or **Down** (↓) to choose **On** or **Off** to enable or disable the function.
3. Press (⊖) beneath **Select** to save the settings and return to the previous menu.

Chapter 4: Ring Tone



This function allows you to change the ring tone of indoor handset (There are three ring tones for your selection).

1. Press **Up** (▲) or **Down** (▼) to choose “Ring Tone” menu, then press (⊖) beneath **Select**.
2. Press **Up** (▲) or **Down** (▼) to select the ring tone that you like. Each time you press **Up** (▲) or **Down** (▼), the indoor handset sounds with the selected volume.
3. Press (⊖) beneath **Select** to save the settings and return to the previous menu.

Chapter 5: Snap Set.

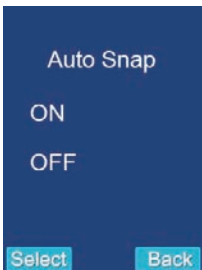

1. Press **Up** (▲) or **Down** (▼) to choose “Snap Set.” menu, then press (⊖) beneath **Select**.
2. Press **Up** (▲) or **Down** (▼) to choose **On** or **Off** to enable or disable the function.
3. Press (⊖) beneath **Select** to save the settings and return to the previous menu.

With this **Auto Snap On**, the camera will take a photo of visitor automatically when visitors press the **Call** button on the door camera. You can pick up this photo easily in the indoor handset.



Notes:

1. During the conversation, if you press the Snap key, the camera can take a photo of visitor and save it into the indoor handset.
2. During the monitoring, if you press the Snap key, the camera can take a photo of the view and save it into the indoor handset.
3. Up to 100 photos can be stored in the handset. The previous ones will be removed automatically if the photos are exceeding 100 pieces in the indoor handset.

Chapter 6: Snap Show



You can view or delete recorded photos in this menu. Door camera number, missed call icon or the corresponding door camera PIR icon will be displayed in the above photos correspondingly.

1. Press **Up** (▲) or **Down** (▼) to choose “Snap Show” menu.
2. Press (◀) beneath **Select**, press **Left** (←) or **Right** (→) to review pictures.
3. If you want to delete the photo, use **Left** (←) or **Right** (→) to choose the photo and then press the (◀) beneath “”. The display will show “?”. Press (◀) beneath “✓” to confirm.
4. : This icon means Delete All. Pressing Unlock key, the system will prompt whether to delete all the photos. Press OK to delete and press Return to exit.
5. After one warning tone, it will display the next photo.
6. Press (◀) beneath (⏪) to return to the previous menu.

Chapter 7: Date&Time



1. Press **Up** (▲) or **Down** (▼) to choose “Date&Time” menu, then press (⊖) beneath **Select**.
2. If you want to set the time, you can press **Left** (◀) or **Right** (▶) to choose the Hour or the Minute and press the **Up** (▲) or **Down** (▼) to adjust.
3. If you want to select the date, you can press **Left** (◀) or **Right** (▶) to choose the Year or the Month or the Date, and press the **Up** (▲) or **Down** (▼) to adjust.
4. Press (⊖) beneath **Select** to save the settings and return to the previous menu.

Notes:

1. Use 24-hour system as time format and YYYY-MM-DD as date format.
2. Date & Time must be set in advance to ensure that the time displayed on the indoor handset is correct.
3. When you replace battery, you must set the time and the date again.
4. The Date & Time setting order is Hour-Minute-Year-Month-Date.

Chapter 8: Door Set.

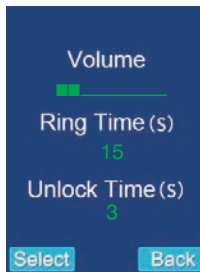

1. Press **Up** (▲) or **Down** (▼) to choose “Door Set.” menu, then press (⊖) beneath **Select**.
2. If you want to adjust the volume of door camera, you can press **Up** (▲) or **Down** (▼) to choose (9 levels are adjustable), and press **Left** (◀) or **Right** (▶) to adjust.
3. If you want to set the ring time, you can press **Up** (▲) or **Down** (▼) to choose Ring Time(1-15 seconds are selectable, when two indoor handsets are connected to one outdoor camera, if the time set in two indoor monitors is different, the time is subject to the shorter one), and press **Left** (◀) or **Right** (▶) to adjust.
4. If setting Ringing Time at 0s, outdoor camera will not make a sound when the call button is pressed.

5. If you want to set the unlock time, you can press **Up** (▲) or **Down** (▼) to choose Unlock Time(1-9 seconds are selectable), and press **Left** (◀) or **Right** (▶) to adjust.
6. Press (⊖) beneath **Select** to save the settings and return to the previous menu.

Note: When there are two indoor handsets connected to one door camera, the setting of these two indoor handsets should be the same.

Chapter 9: Language



1. Press **Up** (▲) or **Down** (▼) to choose “Language” menu, then press (⊖) beneath **Select** .
2. Press **Up** (▲) or **Down** (▼) to choose the corresponding language(0 stands for English,1 stands for Chinese,2 stands for Polish,3 stands for German,4 stands for French,5 stands for Italian,6 stands for Turkish,7 stands for Spanish)
3. Press (⊖) beneath **Select** to save the settings and return to the previous menu.

Chapter 10: Wallpaper



You can choose different wallpaper.

Chapter 11: Version

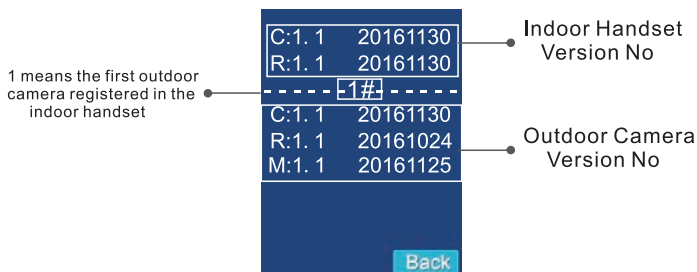

Press **Up** (▲) or **Down** (▼) to choose “Version” menu, then press (⊖) beneath **Select**. You can check the software version in it.

Chapter 12: PIR Settings

1. Press (⊖) beneath Menu on the indoor handset, then select the PIR menu, press **Up** (▲) or **Down** (▼) to choose one door camera (1-2 are selectable) that you want to turn On or Off, and press (⊖) beneath “✓” to confirm the setting. Then the indoor handset will automatically search for the door camera which needs to be registered. There will be a static human icon prompt in the upper left corner, meaning that PIR is turned on.

2. If you want to turn off PIR function of door camera, you can press (⊖) beneath (🗑️). The display will show “🗑️?”, press (⊖) beneath ✓ to confirm. Press (⬅️) beneath (⊖) to return to the main interface. When the PIR function is turned off, the main interface will no longer display PIR human icon.

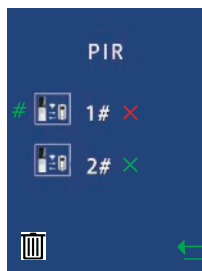
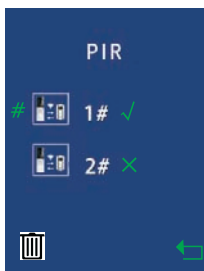

Notes:

1. The PIR will be activated only when door camera is successful in registration. Please refer to Page18-19 of Engineering Model Manual for registration of door camera.
2. When the device isn't registered or fails to register, the PIR interface will show red "X". After registration, the green "✓" will be shown if PIR is turned on and the green "X" will be shown if PIR is turned off.
3. One door camera could connect to two indoor handsets; when any indoor monitor turns off PIR, the PIR display status of another one will change after communication with door camera.
4. Two door cameras also could connect to the same indoor handset. When one door camera's PIR is disabled by the indoor handset, another one won't be affected. Meanwhile, two door camera's PIR could be turned off at the same time.

Chapter 13: Default set.

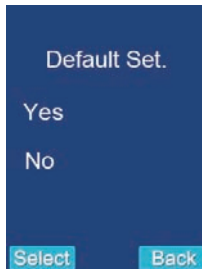

This function allows you to reset the indoor handset to the factory default.

1. Press **Up** (▲) or **Down** (▼) to choose "Reset" menu, then press (⊖) beneath **Select**.
2. Press **Up** (▲) or **Down** (▼) to choose **YES** or **NO** to enable or disable the function.
3. Press (⊖) beneath **Select** to save the settings and return to the previous menu.





Result: After resetting, the indoor handset will return to standby mode.

Note: If you reset the indoor handset, all of the settings will return to the factory default.

Engineering Mode

Register

1. Firstly, insert the small screw driver on “” position inside the battery case of door camera for 3 seconds. Then two backlights of call buttons will lighten, choose one button you want connect to the indoor handset and press it, it will give a sound like “Di”.

Secondly, press  beneath Menu on the indoor handset, select the Register menu, press Up  or Down  to choose one door camera (1-2 are selectable) that you want to connect , and press  beneath “” to confirm the setting. Then the door camera will automatically search for the indoor handset which needs to be registered. When the indoor handset gives an indication tone, it means that it is registered successfully.

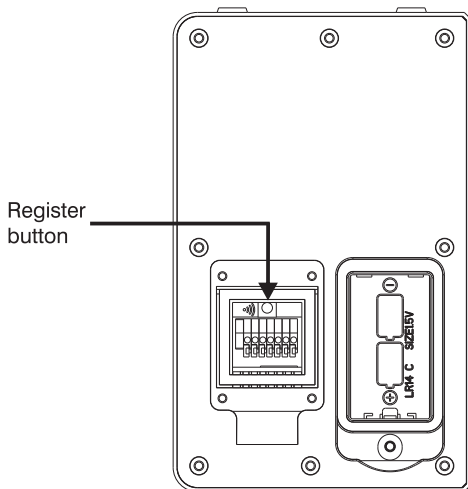

2. Pressing  beneath the Menu and then selecting the Register menu, the system will enter into the following interface. It indicates that the indoor handset is registered successfully.

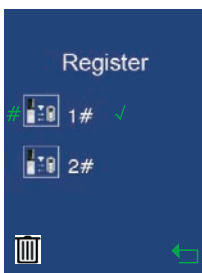

3. If you want to delete the registration, you can press ⊖ beneath 🗑️. The display will show" 🗑️ ?", press ⊖ beneath ✓ to confirm. Press ⊖ beneath ⏪ to return to the main interface.

Notes:

1. The registration of door camera can be up to 60 seconds.
2. The registration of indoor handset can be up to 20 seconds.
3. One Call button can register max 2 indoor handsets.

Power Saving Mode

1. If the door camera is battery-powered, the indoor handset cannot enable monitoring function with factory default. Press register button for 3 seconds and make the door camera enter the registration status. Press register button again for 3 seconds. The door camera will give “bi-bi-bi” tone and switch from power saving mode into power consumption mode. Then the monitoring function is available for the indoor handset.

2. In registration status, press register button for 3 seconds. The door camera will beep and switch from power consumption mode into power saving mode. In this case, the monitoring function is unavailable.





3. Function Details of Device in Different Power Supply Modes:

Power By	Monitoring	PIR
PSU	ON	ON
BAT consumption mode(High)	ON	OFF
BAT consumption mode(Low)	OFF	OFF

Operations



Monitor

As for monitoring function, the LCD will automatically display the corresponding menu in accordance with the registered door camera.

1. In the standby mode, press  beneath **Mon**.
2. With one door camera registered, the indoor handset will enter into monitoring mode directly.
3. With two door cameras registered, the LCD will display Monitor 1# and 2#. You can press Up  or Down  to choose the monitor which you need, then press  beneath Select.
4. In monitoring mode, press **Accept** key to enter into intercom communication.

Note: Monitoring time can last up to 45 seconds.

Alarm

When someone takes the door camera apart from the bracket, the door camera and indoor handset will give an alarm tone. The door camera will first call the main indoor handset, if the main indoor handset doesn't response, the door camera will call the sub indoor handset. The call button is invalid on the door camera. The indoor handset can press  or  to stop alarm sounds.

Notes:



1. The alarm time can be up to 5 minutes.
2. During the alarm, door camera can only connect one indoor handset.

Calling indoor handset

If the visitor presses the **Call** button on the door camera, the corresponding indoor handset rings and the image of the visitor appears on the LCD of indoor handset.

1. If the owner doesn't want to answer, press  to cancel the call.
2. After the owner presses , the indoor handset will stop ringing. Then the conversation starts. Press  or **Call** button to end the conversation.



3. When the door camera calls indoor handset, if the indoor handset has no operation (press  /  / ), the indoor monitor will return to the main interface. The flashing icon of missed call will show in the upper left corner to remind the user of viewing the images. Pressing the End key in the main interface or viewing picture in the “Snap Show” can cancel the flashing icon.

Note: Missed call icon is displayed when Auto Snap is enabled.

Notes:

1. The ringing time can be up to 30 seconds.
2. The conversation can be up to 45 seconds. After 45 seconds, the call will be disconnected automatically.

Indoor Handset activation by PIR

When the PIR detects a movement that lasts for more than 3s, it activates the Indoor handset which will then ring and take a snapshot. The PIR will keep scanning for movement and if it detects anything after 20 seconds, it will take another snapshot and keep monitoring the area for further movement (if no movement is detected at this point, the PIR will stop and the handset will return to standby mode). If another movement is detected after 40 seconds, another snapshot will be taken. At this point, the PIR will stop and the handset will return to standby mode. The PIR will switch into Sleep Mode and won't see any movement for 3 minutes (operating the Indoor Handset during that time will not interrupt the Sleep Mode).

Notes:

1. The PIR will not respond to any movement when the call button is pressed or an alarm occurs. It will resume scanning for movement once these events are over.
2. When the Indoor handset returns to standby mode after being triggered by PIR, a running man icon will appear on the screen and keep flashing to notify the user that the PIR has been triggered and that new unseen snapshots are available to view. Pressing the End key or viewing the snapshots in the "Snap Show" will remove this icon.



Notes:

1. During PIR surveillance, when call button is pressed or an alarm occurs, PIR will be disabled and enter calling or alarm mode.
2. When the PIR finishes the call and returns to the main interface, the body icon will flash to remind the user of viewing the snapshot. Pressing the End key in the main interface or viewing picture in the "Snap Show" can cancel the flashing icon.
3. Every indoor handset can control the PIR. If the indoor handset A disables the PIR but the indoor handset B doesn't, when the PIR has been trigger, the door camera will call the indoor handset B.

Unlocking

During conversation or monitor status, press  button to unlock the door.

Backlight

1. If the door camera is supplied by DC 12V, the backlight of call button is on.
2. If the door camera is supplied by battery, the backlight of call button is off.
3. In the registering, calling, alarm, monitoring and intercom status, the backlight will flash.

Note: During the calling, alarm or monitoring status, if the door camera is powered by battery in power saving mode, the backlight of call button will be off without flashing.

Technical Parameters

Item	Detail
Door Camera	
Transmit Frequency Range	2.4GHz - 2.4835GHz
Data Rate	2.0Mbps
Transmitting Power	19dBm (TYP)
Modulation Type	GFSK
Transmitting Distance(in open area)	about 500m
Image Sensor Type	Color CMOS Image sensor
Image Processing	H.264
Camera Pixels	640*480
White Balance	Auto
Viewing Angle (Diagonal)	120°
LED	6 LEDs
Power Requirement	(+9V-12V)±5%/ 2*LR14(C),1.5V batteries
Power Consumption	500mA Max(Cells) 200mA Max(+12 V DC)
Operating Temperature	-20℃ ~ +55℃
Operating Humidity	20%-80%
Size(W*H*D)	105*167*50mm
No. of indoor handset supported	Max.4
PIR	2.5m*100°

Technical Parameters

Item	Detail
Indoor Handset	
Receiving Frequency Range	2.4GHz - 2.4835GHz
Monitor	2.4" Color LCD
Data Rate	2Mbps
Receiving sensitivity	-85dBm
Demodulation Type	GFSK
LCD Resolution	320X240(RGB)
Transmitting Power	19dBm (TYP)
Power Requirement	BL-5C, 3.7V, 1100mAh(lithium battery)
Power Consumption	400mA Max
Operating Temperature	-10℃ ~ +40℃
Operating Humidity	20% ~ 80%
Size(W*H*D)	Indoor Monitor:51*152*19.5mm Charger base:123.5*119*37.5mm
No. of door camera supported	Max.2

Notes on Installation & Usage

Since working frequency of this product is 2.4G, wavelength is short and wireless signal has poor penetration, the device will get disturbed from other products of the same frequency. In order to ensure smooth communication, please note the following.

1. It's best to install door camera in a place away from rain and wind. Try to avoid the sunlight into camera lens. Do not place the door camera directly on metal security door, because metal will have barrier effect on the signal. Door camera can be installed on the wall nearby.

2. Since the product is straight line transmission, try to reduce the obstacle between door camera and indoor handset. The obstacle will weaken the signal. In the case that there is the obstruction which affects transmission distance, please shorten the distance between transmitter and receiver if possible when meeting usage needs. When the product goes through different obstructions, general signal attenuation situation is as below:

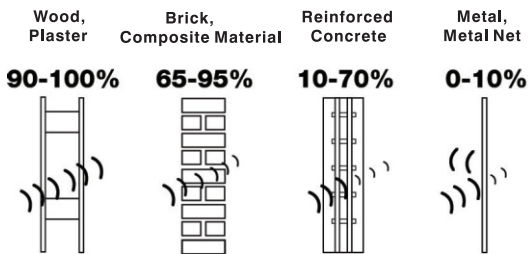

Remaining signal percentage is shown above after radio wave passes through the obstructions of different materials.

3. Do not put any product of the same frequency such as router, bluetooth device and microwave oven next to our device in order to avoid causing the interference and shortening of communication distance. If the number of walls between outdoor camera and indoor handset results in ineffective communication, please adjust the location of two devices to reduce wall number between two devices over a horizontal distance. When outdoor camera is in communication with indoor handset, if someone walks on the distance between two devices, the communication might be less effective. The indoor handset cannot be put in low-lying place or corner.

Away from electrical appliances, such as a TV, personal computer or another cordless phone.

In a HIGH and CENTRAL location with no obstructions such as walls, microwave oven and WIFI.

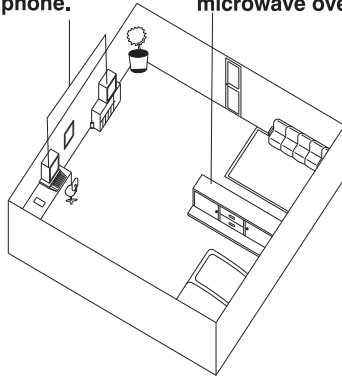

Location Diagram 1 of Indoor Handset

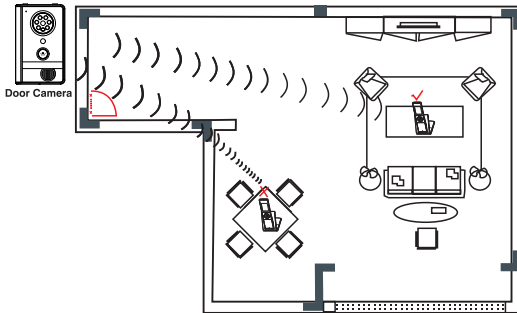

Location Diagram 2 of Indoor Handset

Safety Instructions

In order to protect you and others from harm or protect your device from damage, please read the following information before using the device.

Do not install the device in the following places:

- Do not install the device in high-temperature and moist environment or the area close to magnetic field, such as around electric generator, transformer or magnet.
- Do not place the device near heating products such as electric heater or the fluid container.
- Do not place the device in the sunshine or near the heat source, which might cause discoloration or deformation of the device.
- Do not install the device in an unstable position to avoid the property losses or personal injury caused by the falling of device.

Guard against electric shock, fire and explosion

- Do not use damaged power cord, plug or loose outlet.
- Do not touch the power cord with wet hands or unplug the power cord by pulling.
- Do not bend or damage the power cord.
- Do not touch the device with wet hands.
- Do not make the power supply slip or cause the impact.
- Do not use the power supply without the manufacturer's approval.
- Do not have the liquids such as water go into the device.

Clean Device Surface

- Clean the device surfaces with soft cloth dipped in some water, and then rub the surface with dry cloth.

Other Tips

- In order to prevent damage to the paint layer or the case, please do not expose the device to chemical products, such as the diluent, gasoline, alcohol, insect-resist agents, opacifying agent and insecticide.
- Do not knock on the device with hard objects.
- Please be careful when standing up from under the device.
- Do not disassemble, repair or modify the device at your own discretion. The arbitrary modification is not covered under warranty. When any repair required, please contact the customer service center.
- If there is abnormal sound, smell or fume in the device, please unplug the power cord immediately and contact the customer service center.
- When the device isn't used for a long time, the adaptor and memory card can be removed and placed in dry environment.

